



# Wall Charger 2 Installation Guide

## 7.4kW SOCKET SINGLE PHASE:

EVWC2S7G (7.4KW / WI-FI / LAN)

EVWC2S7GG (7.4KW / WI-FI / LAN / 4G)

EVWC2S7GGR (7.4KW / WI-FI / LAN / 4G / RFID)

## Contents

*click to navigate directly to the page*

[Introduction / Box contents](#)

[Safety information](#)

[Installation & testing](#)

[Troubleshooting](#)

[Commercial Installation & Commissioning](#)

[Domestic Commissioning  
Stage 1 \(Installer app\)](#)

[Domestic Commissioning  
Stage 2 \(User app setup\)](#)

[Technical](#)

# Introduction

This guide is intended for use by competent electrical installers to explain basic requirements and options to be considered when installing a BG SyncEV charger. The unit is designed for installations inside or outside, the advanced safety technology we have built into the unit ensures its safe usage. This guide provides information to assist when installing the EVWC2Sx chargers and should not be used with other EV chargers.



---

## Box contents

- EV charger
- Decorative fascia
- Installation template & quick start guide
- Accessories pack containing:
  - » Power connector
  - » Cord grip and screws
  - » M25 gland
  - » 25mm blind grommet
  - » Bonded sealing washers
  - » Assembly screws
  - » Anti-tamper bit
  - » x1 CT clamp (EVA120CT1)
  - » x1 CT clamp connector (For load balancing and Integrated SolarCharge feature)
  - » x1 RFID Key fob (EVWC2S7GGR only) (Additional key fobs can be ordered using the code EVXRFDIFOB-01)

---

## Tools required

Hex bit holder, PZ2 screwdriver, suitable drill bit and fixings

# Safety information

**Warning:** The supplied BG SyncEV charger is manufactured to be safe without risk provide they are installed correctly, used, and maintained in accordance with the manufacturers recommendations and installed by a competent electrical installer in accordance with national and local regulations and legislation applicable at the time of installation, e.g. BS7671:2018 amendment 2.

The EV Charger is suitable for use with a single phase (for up-to 7.4kW charging) 220-240V Nominal AC supply.

The supply should run from a dedicated 40A circuit breaker. We recommend the use of a Type B curve circuit breakers. The EV charger features an integral 30mA type-A RCD with 6mA DC leakage detection and therefore an external RCD is not usually required:

1. For cables without earthed metallic covering installed in walls or partitions at a depth of less than 50mm and also within walls and partitions with metal parts, and not protected by steel conduit or similar then RCD protection is required.
2. If the cable is clipped directly to the surface of a wall and does not pass through a wall or partition to the EV charger then a standard B type 40A MCB may be installed into the Consumer unit, however RCD protection may be required for other reasons such as if it forms part of a TT system and the earth fault loop impedance values cannot be met. This will be in compliance with the current BS7671

Amendment 2 Wiring Regulations.

To conform with BS 7671, on occasions a two pole MCB/RCD or other means of isolation may be required.

**Important note:** A DC Leakage fault in the vehicle may "blind" a type "AC" RCD and render it ineffective, never feed any EVSE From an upstream Type "AC" RCD.

## Earthing requirements

The supplied EV charger features an on-board safety monitoring system to detect low or high voltage supplies and potential earth-neutral faults, this in accordance with regulation 722.411.4.1 (iv) of BS7671 2018. If such a condition is encountered the charge cycle is ended or prevented and the EV charger indicator flashes red and effectively becomes a double insulated (class II) device. The vehicle becomes isolated in accordance with Regulation 543.3.3.101(ii) from incoming supply and poses no risk to touch. This feature removes the requirement for an earth electrode where it may be ineffective or introduce further risk.

The EV charger may be connected directly to a TN-C-S (PME) earthing system without any special arrangements. It remains the responsibility of the installer to conduct a risk assessment of the immediate area to a range of 10 meters (equipotential zone) to ensure no other conductive metal fixings pose risks (mixture of TT/TN-S and TN-C-S), this is important where cable length may enable charging inside or outside of a building/ garage where the vehicle is within touch distance.

Where certain conditions dictate an earth electrode must be used it shall be independent

from the distributors earth system with no direct interconnection (the incoming supply SWA protective earth should be isolated from the housing and/ or earth electrode). The electrical installer shall install a suitable electrode complete with termination housing and covers where appropriate, warning labels should be visible and close to the unconnected SWA protective earth, e.g. inside the charger.

The earth connection shall be made from the electrode to the charger via copper conductor earth wire of an appropriate CSA for the installation. The earth wire shall be installed in conduit where there is a risk of mechanical damage or UV exposure. Recommended Earth electrode impedance to be <100 ohms.

# Surge protection

Guidance on requirements for surge protection devices given in BS7671: section 443.

The EV charger is protected against transient over voltages ( $\pm 2\text{kV}$  Line-Earth and  $\pm 1\text{kV}$  Line-Line as a requirement of EN 61000-6-1), a direct lightning strike carries a current of 30~200kA the EV charger's internal protection would provide little or no protection in such an event, likewise nor would an SPD rated less than 30kA. If life support equipment or business operations could be affected by a lightning strike central SPD protection is advised if it does not already exist.

The guidance on risk calculation in section 443.5 of BS7671 in most cases is not possible due to unknown location of any SPD already fitted, length of cables to calculate LP etc, it is therefore recommended a common sense approach is used on choice of SPD (or if required).

# Isolation and switching for safety and maintenance

To ensure the EV charger can be "turned off" to enhance security and enable maintenance activities, a two pole isolator (or DP RCD or RCBO) suitably rated must be installed within the customer's property.

An isolator switch is a mandatory requirement for "new builds", but optional for existing dwellings (at customer's request), the switch should be mounted between 500mm and 1500mm above finished floor level to comply with regulations. The switch should be rated at 45 Amps. All installations must comply to BS7671: 2018.

# Installation requirements

The EV charger is suitable for installation inside and outside on a solid wall or structure.

The installer should consult with the building owner to establish their preferred installation location.

This should take into consideration the length of charging cable and risk of vehicle impact etc.

It is recommended the charger is installed at a height of 500mm-1500mm as per building regulations BS8300:2018.

If no suitable permanent structure is available, the EV charger can be mounted to a stand. We recommend of the Sync Energy stand, EVASTAND12S (single) or EVASTAND12T (twin).

Ensure suitable fixings are used depending on the mounting surface. To avoid unnecessary dust inside the enclosure, it is recommended to use the included fixing hole template drill the surface, before fitting the enclosure.

Ensure installation wall has been checked for electric cabling or pipework with a suitable detector.

**NOTE:** if any groundworks are required e.g. cable trenching or earth electrode fitment, it is advisable to check if underground services could be present before commencement. Plans may be available at: [www.linesearchbeforeudig.co.uk](http://www.linesearchbeforeudig.co.uk) (free to domestic users).



The EV charger is suitable for bottom or rear cable entry, if using rear cable entry ensure the included 25mm rubber grommet is used to maintain the IP rating.

If using SWA cable the included 25mm compression gland is NOT suitable, an alternative gland will be required.

When using SWA please supply the charger from the bottom left cable entry point.

A maximum hole size of 32mm is acceptable at this location. Its advisable to earth the SWA armouring at the supply end of the cable.

Do not drill alternative cable entries into the charger housing, except marked cable entry location for rear or bottom entry.

We recommend using BG SyncEV Power & Data Combined cable on installs that require a CT clamp to use the chargers dynamic load management capabilities.

All of the cables that are to be connected in to the supply connector should have their insulation striped back 18-20mm. Connectors supplied are suitable for cables of 4-10mm<sup>2</sup>.

# Load balancing / Integrated Solar Charge Feature

If load balancing and/or Integrated SolarCharge feature is required, a single CT clamp should be used for correct balancing. One BG SyncEV CT clamps, EVA120CT1, is supplied in the box with this charger. This should be fitted around the incoming power to the main fuse and the correct max load (A) to be entered during setup and installation steps.

- 1 Locate the main incoming power cable into the property. The CT Clamp needs to be fitted before any of the tails are split for correct measurement.

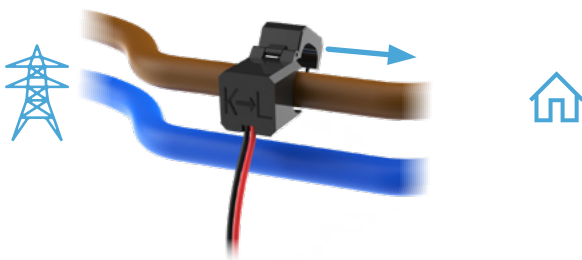

- 2 Open the CT Clamp and fit around the incoming Live power cable, this is typically marked brown for most installations.

Ensure the Arrow is pointing into the property from the incoming fuse.

K towards Source, L towards Load.

- 3 CT Clamp current and voltage readings can be checked via the Bluetooth EV installer App to ensure correct connection and orientation.

## Load Balancing Multiple chargers

If load management for more than 1 charger is required please see EV Balancer at sync.energy for more details on how to dynamic load manage up to 16 chargers at once.

## MID Meter For Billing Purposes Only

If a MID Meter is required for Billing purposes – chargers can communicate on the RS485 connection, this will require the DIP switches to be set for this. DIP 3 Up/On is required as default will be off.

## Final Electrical testing

To meet the BS7671:2018 (18th edition) requirements for testing of an electrical installation, the following tests and checks shall be performed by a competent electrical installer before during and after a BG SyncEV charger is installed:

- A visual inspection of the installation including the existing electrical installation.
- Verification of the characteristics of the electrical supply at the origin of the installation to confirm the supply is suitable for the additional load.
- A test to confirm the continuity of the circuit protective conductors.
- A test to confirm the integrity of the circuit insulation resistance.
- A test to confirm the polarity of the installation is correct.

- Where applicable a test to confirm the earth electrode resistance is within acceptable tolerances.

(or)

- An earth loop impedance test.
- A test of the mechanical operation of residual current devices (RCD's).
- A test to confirm the operation of residual current devices (RCD's) is within stipulated time scales (at the rated current and at five times the rated current operating current).
- A test or calculated measurement of the prospective fault current.
- A verification of the functional operation of the EV charger.
- An electrical installation certificate must be completed.

Ensure electrical testing is done before EV charger commissioning and network setup is performed.

For this testing, the Charger can be set to **"Plug and Charge"** Mode or Installation Mode can be enabled in the installation App.

# Electrical Installation

- 1 Isolate the power



- 2 Use the included hole template to drill fixing holes



3

Drill base for required cable entry.  
Suitable for 16-32mm hole size.  
If using rear entry, ensure included  
25mm grommet is used



Left for  
SWA cable

Right for rubber/  
flex cable

4

Ensure the supplied washers are  
used to maintain IP rating



5

Ensure correct polarity when making incoming power connections

3 pin plug:

N - Blue

E - Yellow/Green

L - Brown

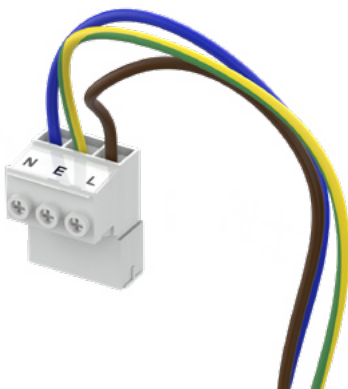

6

Ensure supplied cord grip is fitted on incoming power cable if using bottom cable entry location

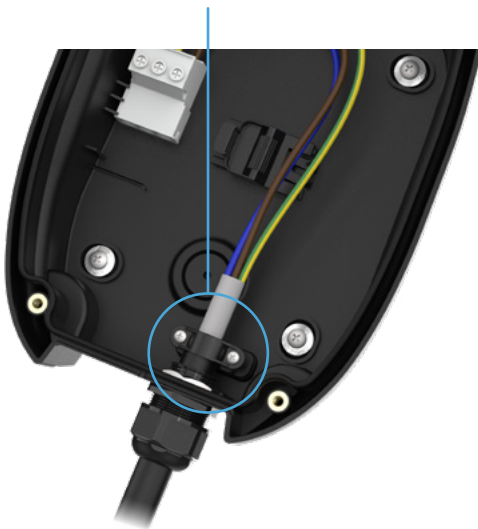

7

Ensure Power connector is fully inserted then slide clip to secure

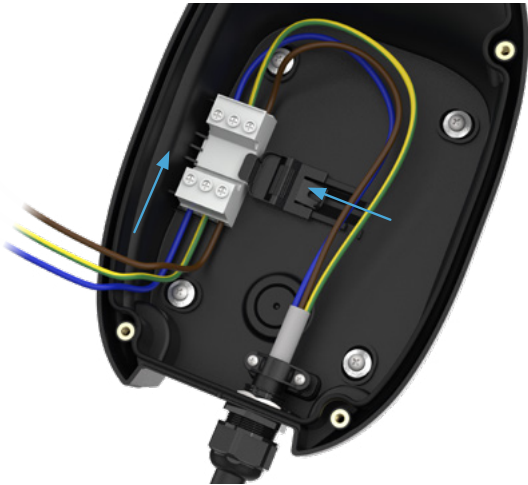

8

For dynamic load balancing, insert wires into the small connector  
If using external 485 meter, then dip switch 3 needs to be changed to 'On'

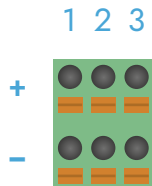
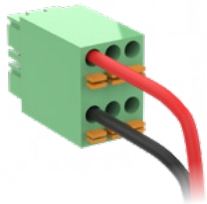

	1	2	3
+	485A		CT+
-	485B		CT-



9

Plug connector into PCB, ensure correct polarity

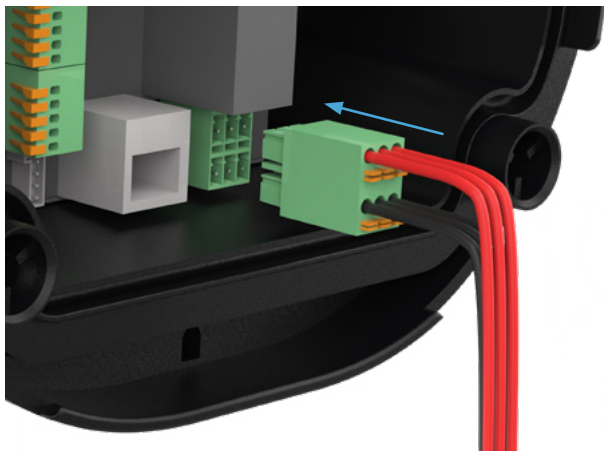

10

Fix charger to the base ensuring correct torque settings

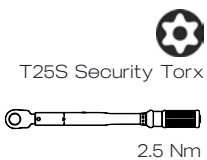

- 11 Snap front cover trim into place



- 12 Fit locking screw to secure cover



# Troubleshooting

For further information, or to refer to our FAQs, please visit our website: [www.sync.energy](http://www.sync.energy)

The status of the EV charger can be identified by referencing the colour shown on the LED indicator:

- **Solid Blue – Standby** – Charger has power and is connected to the network. Or, if in 'plug and charge' mode is not connected to the network, is ready to charge.
- **Flashing BLUE** – Charger is connected but not charging, awaiting confirmation of charge in APP or scheduled start time
- **Solid Dark Green** – Charger is active and Charging
- **Solid Yellow** – Charger is offline from network, check local network is active and Wi-Fi is working on the 2.4Ghz band
- **Flashing Red** – Indicates the charger is in fault mode and has stopped charging for users safety
- **Flashing Purple** – Communication issue to Balancer hub, or Balancer load management set to on by mistake. Check installer App settings

Potential causes:

- Internal RCD has tripped
- Vehicle fault
- Under or over suitable charging voltage

Remove connection to the vehicle and reset power to the EV charger.

# Commercial / Workplace / Fleet installation & commissioning

## 4 simple steps:

### 1 CONTACT

Email [commercial@sync.energy](mailto:commercial@sync.energy) with the charge-point owner contact details

---

### 2 CONNECT

Install the charge-points

---

### 3 CONFIGURE

Set the configurations in the BG SyncEV installer app and connect all chargers to the internet

---

### 4 COMPLETE

Pass the charger details to the charge-point owner

---

## How it works:

To streamline the process, email us [before the first day of installation](#) with the following information:

- **Model and charger ID**  
(for every charger in the installation)
- **Contact details for the charge-point owner:**
  - Company name
  - Name of charge-point manager
  - Site address
  - Telephone number for charge-point manager
- Email address for charge-point manager  
Our Commercial Team will contact the charge-point owner to carry out the quick and simple Monta setup process.

**By using this process we will have the back-office set up for installation day, ensuring all chargers are immediately ready for customer use once configured.**

# Domestic Commissioning Stage 1 of 2

INSTALLER APP – [Download the 'Sync Energy' app by clicking this link](#)

Also available from the Installer Portal on the [sync.energy website](#), or using the QR code opposite.



**Intuitive Interface:** The revamped interface is designed with the installer in mind. Everything you need is available through a new side-menu.

**Effortless Setup:** seamlessly configure your EV Chargers and Balancer devices with just a few taps. Get up and running in no time.

**Account Management:** Create and manage your account effortlessly. Keep a history of all your installed Chargers.



Upon powering the charger, the status indicator light will show **Yellow**. This indicates that the charger is ready for network setup but is not yet connected to the internet. These steps are still required for 4G connected versions for setting of Dynamic Load Management.

For Wi-Fi connection, we recommend that the router is set to only 2.4GHz band to reduce the risk of possible conflicts. Once setup the router can be restored to both 2.4Ghz & 5Ghz bands.

# 1

Open the SyncEnergy Installer App, If this is the first time you will be required to create an account. This will give you a history of the chargers installed and further help options.

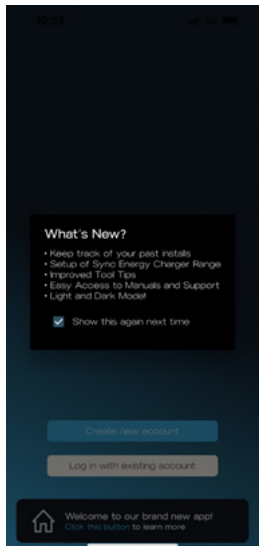

2

Ensure Bluetooth is activated on your device and select set up new product. If the EV charger does not show up under EV Charger option, go back and select show all Bluetooth devices. If no Bluetooth devices are shown, please check Bluetooth is turned on and the permission was granted in the app.

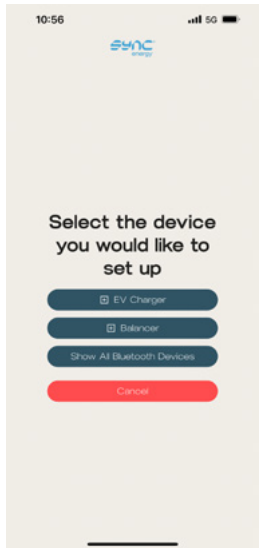

3

Select the correct EV Charger that matches the Charger ID code as shown on the charger identification label.

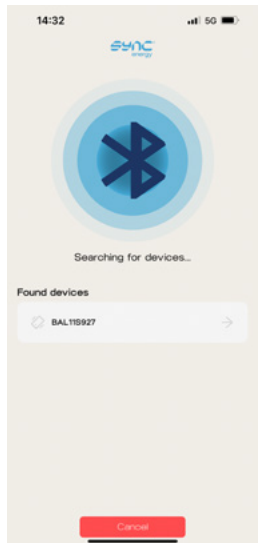



4

Then enter the password/PIN shown on the identification label.

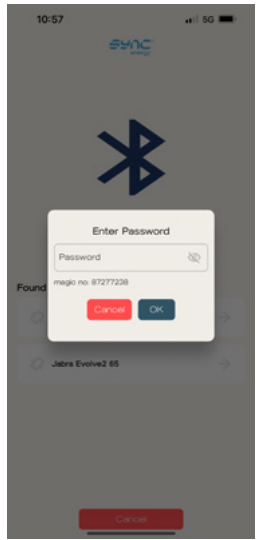

5

Depending on firmware version installed at the charger at the point of installation, you may see a different homepage in the App. Latest firmware will allow a RCD function test to be done on the chargers internal RCD to check periodically, This test is also done automatically at every power cycle and charge start.



- a. Full EV Charger Setup allows full set up of Load balancing and other settings.
- b. Network Set up allows quick Wi-Fi or Lan connection to be changed and set up

6

### Charger Server:

Select "Monta" – this is the included App. "Ev. Energy" and "SyncEV" are alternative options (additional costs may be incurred). "Manual" can be used for other alternative back offices. If unsure, Choose "monta".

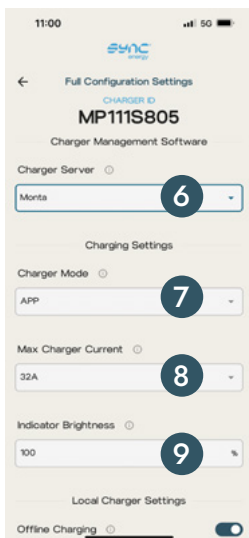

7

**Charger Mode:** "APP" for smart charging via the consumer App (see next page); "Plug and Charge" if connection to the server cannot be established and immediate car charging is required.

8

**Max Charger Current:** Set to max current supported by installation if less than the default 32A.

9

**Indicator Brightness:** Adjust from 1 to 100% to change the brightness of the status indicator.

10

### Local Charger Settings:

Offline charging is enabled as default, for commercial paid charging we recommend this is disabled. This controls if the charger will allow a charge to start while not connected to the back office system.

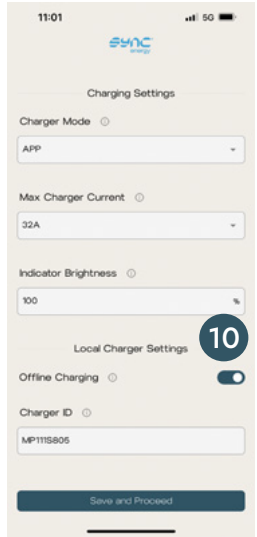

11

Charger ID can be changed as required for other user Apps. We Recommend this is not changed unless critically required. Press Save and Proceed to the save these settings.

12

### Dynamic Load Management:

If Dynamic Load management or Integrated SolarCharge is required, then toggle right and select Single CT Clamp. Enter the properties fuse or maximum circuit rating. This will reduce the charge rate if the property is near the set limit.

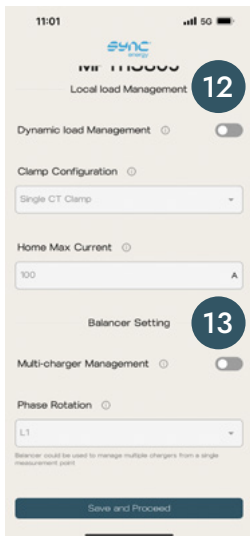

13

**Balancer:** This should be enabled if using the Balancer Multi-Charger hub, and then the correct phase rotation enabled. Circuit limits are set on the balancer unit only. Press Save and Proceed to save these settings.

Check the shown electrical measurements match the measured readings. This will allow checking the load management CT is fitted in the correct orientation and location. A negative value indicates reverse direction of power due to, e.g Solar surplus, but could also indicate that the clamp has been installed in a reversed (incorrect) orientation or polarity wiring.

If it shows up as "Check CT Clamp", check connections.

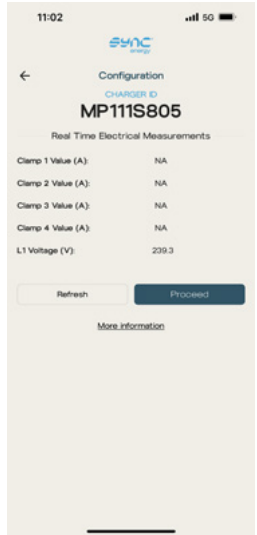

# Network Set up

## 15

For connecting to the network, ensure the required connection method is enabled. Choose between Wi-Fi, 4G (where supported) and LAN.

- For Wi-Fi, select the SSID network name and enter password,
- For LAN, ensure that "Manually Set Static IP Address" is disabled (unless advanced settings are required)
- For 4G, the settings will have been pre-configured where supported. (EVWC2xxGG GGR models only)

Multiple options can be selected if required, this will allow a fall-back, e.g from Wi-Fi to 4G if fitted in case of network loss.



16

On LAN, the charger will default to DHCP. If static IP is required for the network connection, set the option "manually Set Static IP Address" to On and a manual IP address can be entered.

17

Press Save and Proceed to start network connection.

18

The Charger will attempt a network connection, if successful will then reboot to complete a RCD and safety function check.

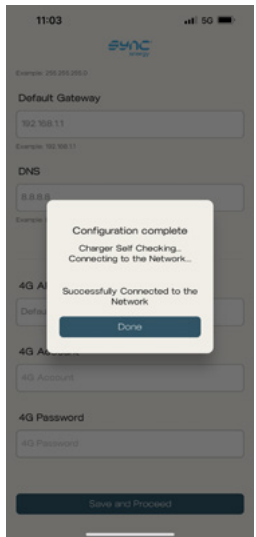



In less than 2 minutes, the indicator should turn from Yellow to Blue to confirm network connection.

If the charger continues to show yellow, power cycle (switch off/on at fuse board) and reconnect via the app to check the settings are correct.

If still unable to connect to the network but need to use the charger then change the Charge Mode to 'Plug and Charge' and press 'SET' again to re-update settings.

If unable to establish network connection call [01952 983 940](tel:01952983940)

or email: [support@sync.energy](mailto:support@sync.energy)

**Note:** The network connection from the device to the Internet is fully encrypted and secure. Additionally, no user data is stored on the charger.



# Domestic Commissioning Stage 2 of 2

1. Download the Monta smart app:

[Apple app store](#)  
[click here](#)



[Google play store](#)  
[click here](#)



or search for '**Monta EV charging**' on  
Apple app store or Google Play

2. Using your smart-phone scan the unique  
Monta QR Code on the '**Quick Start Guide**'  
sheet supplied with the EV Charger.  
If you're unable to use the QR, open a web  
browser on your smart-phone and manually  
type the URL on the sticker
3. Open the Monta app

iOS



Android

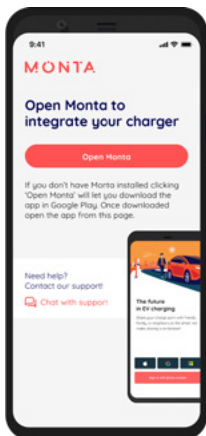

4. Create an account using your customers phone number or social logins (Apple/Google/Microsoft)



5. Connect the EV charger to Monta - name the charge-point and set the location

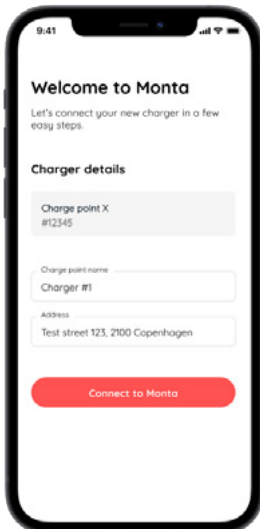

6. Successful connection – When you reach this step, your charge-point is connected and you can use Monta to start charging

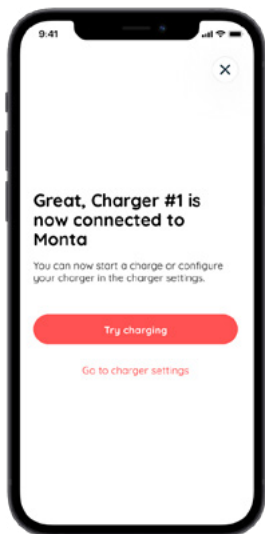

### **Need help with the app?**

Contact Monta customer support through the app or via the website [Monta.com](https://www.monta.com)

### **Need help with the charge-point?**

Contact Sync Energy technical support at: [support@sync.energy](mailto:support@sync.energy) or via the website at [www.sync.energy](https://www.sync.energy)

# Technical information

## Environmental Protection



This symbol is known as the "Crossed-out Wheellie Bin Symbol". When this symbol is marked on a product or battery, it means that it should not be disposed of with your general household waste. Some chemicals contained within electrical/electronic products or batteries can be harmful to health and the environment. Only dispose of electrical/electronic/battery items in separate collection schemes, which cater for the recovery and recycling of materials contained within. Your co-operation is vital to ensure the success of these schemes and for the protection of the environment.

## Guarantee

BG Sync EV products are guaranteed against faulty materials and workmanship for a period of 3 years from date of delivery: products will be repaired or (at Sync Energy's discretion) replacements will be supplied or (at Sync Energy's discretion) a credit note will be issued.

This guarantee is subject to Sync Energy's conditions of sale and in particular to the following conditions being met:

1. Notification of any defect is given to Sync Energy as soon as reasonably practicable after becoming apparent, and the products then returned to Sync Energy.
2. The products have only been operated under normal operating conditions and have only been subject to normal use.
3. No work (other than normal and proper maintenance) has been carried out to the products without Sync Energy's prior written consent.
4. The products have been assembled, or incorporated into other goods, by a qualified and recognised electrician and only in accordance with any instructions issued by Sync Energy.
5. The defect has not arisen from an item manufactured or supplied by a person other than Sync Energy.
6. 3 year warranty as standard, optional product registration can be completed on the Sync Energy website.

[Follow this link to visit our Warranty web-page](#)



# Technical data

<b>CODES:</b>	EVWC2S7G (7.4KW / WI-FI / LAN) EVWC2S7GG (7.4KW / WI-FI / LAN / 4G) EVWC2S7GGR (7.4KW / WI-FI / LAN / 4G / RFID)
<b>TYPE:</b>	SOCKETED
<b>SOCKET / PLUG:</b>	TYPE 2 SOCKET WITH AUTO LOCK
<b>KW:</b>	SINGLE PHASE: 7.4KW, 32A MODE 3
<b>MIN CHARGE CURRENT:</b>	CONFIGURABLE, 6 – 32A
<b>ELECTRICAL INPUT:</b>	SINGLE PHASE: 220-240V, 50-60Hz
<b>COLOUR:</b>	BASE & BODY RAL 9005 (BLACK) TRIM – RAL 7016 (ANTHRACITE GREY) OPTIONAL COLOURED TRIMS AVAILABLE AS ACCESSORIES
<b>CABLE MANAGEMENT:</b>	BUILT IN CABLE WRAP
<b>PEN PROTECTION:</b>	YES, IN-BUILT EARTH DISCONNECTION
<b>EARTH ROD:</b>	NOT REQUIRED
<b>RCD PROTECTION:</b>	YES, 6mA DC, 30mA AC TYPE-A, IN-BUILT
<b>OVERLOAD AND FAULT PROTECTION:</b>	OVER CURRENT AND FAULT PROTECTION
<b>ELECTRICAL CLASS:</b>	CLASS 1, HOUSING CLASS 2
<b>CONSUMER UNIT REQUIREMENTS:</b>	40A MCB OR 30mA TYPE-A RCD (DEPENDENT ON CABLE TYPE &/OR ROUTE)
<b>LOAD BALANCING:</b>	1x EVA12OCT1 LOAD MANAGEMENT KIT INCLUDED

<b>METER ACCURACY:</b>	2% CLASS C EQUIVALENT INTERNAL METER WITH OPTION FOR CONNECTION TO EXTERNAL RS485 MODBUS METER
<b>TERMINALS:</b>	COMBI SCREW FIRST FIX PLUG CONNECTOR
<b>INDICATOR:</b>	RGB LED AND BUZZER
<b>INDICATOR MODES:</b>	BLUE - STANDBY, FLASHING BLUE - PREPARING, GREEN - CHARGING, YELLOW - NO NETWORK, RED - ERROR
<b>HOUSING:</b>	UV STABILISED POLYCARBONATE
<b>WALL FIXING:</b>	4 POINT WITH HORIZONTAL AND VERTICAL ADJUSTMENT, SUPPLIED FIXING HOLE TEMPLATE. FIXING HOLE CENTRES: 110 HORIZONTAL, 145 VERTICAL (MM)
<b>IP / IK RATING:</b>	IP55 / IK10
<b>SOC MODULE:</b>	AI ESP32-S SOC
<b>WI-FI &amp; ETHERNET:</b>	2.4Ghz 802.11 B/G/N & RJ45
<b>WI-FI SECURITY:</b>	WPA/WPA2/WPA2-ENTERPRISE/WPS
<b>BLUETOOTH:</b>	4.2 BR/EDR and BLE
<b>CONNECTION PROTOCOL:</b>	OCPP 1.6J
<b>4G DATA:</b>	MODEL SPECIFIC 3 YEARS INCLUDED, WHEN USED WITH MONTA (ON THE INCLUDED PACKAGE). TOP-UP ONLINE TO CONTINUE SERVICE AFTER 3 YEARS
<b>APP:</b>	POWERED BY MONTA
<b>OPERATING TEMP:</b>	-25 TO +40°C
<b>SOFTWARE &amp; FIRMWARE UPDATE:</b>	OVER-THE-AIR
<b>WARRANTY:</b>	3 YEARS

**STANDARDS & APPROVALS:**

IEC61851-1, IEC61439-7, IEC62955, IC 61851-21-2, BS EN62196, EN301 511, EN 301 908-1/2/13, EN 301 489-3, EN 300 330, EMC COMPLIANT, CE, UKCA, THE ELECTRIC VEHICLES (SMART CHARGE POINTS) REGULATIONS 2021 INCLUDING SCHEDULE 1

**SUPPLIED ACCESSORIES:**

1x EVA120CT1 LOAD MANAGEMENT KIT, 5x BASE FIXING WASHERS, 5x ASSEMBLY LID BOLTS, 1x BLANKING PLUG AND 1x 25MM COMPRESSION GLAND, USER-SIDE CONNECTOR, CORD GRIP AND 2x CORD GRIP ASSEMBLY SCREWS

**DIMENSIONS (MM):**

305 (H) x 201 (W) x 115 (D)

**ADDITIONAL:**

ANTI TAMPER DETECTION - 2 LAYER PROTECTION, BLUETOOTH TO BLUETOOTH COMMISSIONING

**ACCESSORIES:**

SINGLE CHARGER STAND (EVASTAND12S)  
TWIN CHARGER STAND (EVASTAND12T)  
CHARGING CABLES  
COLOURED TRIMS  
(VARIOUS OPTIONS, SEE Sync.energy)

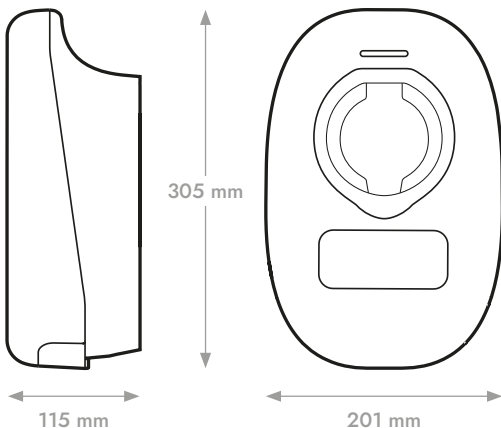



# Technical support

Need help with the app?

Contact Monta customer support through the app or via the website [Monta.com](https://Monta.com)

Need help with the charge-point?

Contact Sync Energy technical support at:

[support@sync.energy](mailto:support@sync.energy)

or via the website at [www.sync.energy](https://www.sync.energy)

**Sync Energy (previously BG SyncEV)  
is a trading name of Luceco PLC**

**Luceco PLC**

Stafford Park 1, Telford, TF3 3BD, England

**(EU) Luceco SE**

C/ Bobinadora 1-5, 08302 Mataro, Spain