



PROCHARGER

Installation Guide

2 X 7.4KW DUAL WALL CHARGER:

EVPCWSM27BGR (WI-FI / LAN / 4G / RFID)

EVPCWSM27BGRP (WI-FI / LAN / 4G / RFID / Payment Terminal)

Contents

click to navigate directly to the page

[Introduction / Box contents](#)

[Safety information](#)

[Installation & testing](#)

[Troubleshooting](#)

[Commercial Installation & Commissioning](#)

[Domestic Commissioning
Stage 1 \(Installer app\)](#)

[Domestic Commissioning
Stage 2 \(User app setup\)](#)

[Technical](#)

Introduction

This guide is intended for use by competent electrical installers to explain basic requirements and options to be considered when installing a Sync Energy charger. The unit is designed for installations inside or outside, the advanced safety technology we have built into the unit ensures its safe usage. This guide provides information to assist when installing the Pro Charger Range of EV chargers and should not be used with other EV chargers.



Box contents

- EV charger
- Decorative fascia
- Quick start guide
- Accessories pack containing:
 - » Assembly screws
 - » Anti-tamper bit
 - » x2 RFID Key fob (Additional key fobs can be ordered using the code EVXRFIDFOB-01)
 - » **Note** – Compatible with CT Clamps & Balancer supplied by Sync Energy

Tools required

Hex bit holder, PZ2 screwdriver, suitable drill bit and fixings.

Safety information

Warning: The supplied Sync Energy charger is manufactured to be safe without risk provide they are installed correctly, used, and maintained in accordance with the manufacturers recommendations and installed by a competent electrical installer in accordance with national and local regulations and legislation applicable at the time of installation, e.g. BS7671:2018 amendment 2.

The EV charger should be connected to a single phase supply 230/240V nominal AC Supply.

The supply should run from a dedicated circuit breaker for EV Charging between 40-100A. We recommend the use of a Type B curve circuit breakers. The EV charger features an integral 30mA type-A RCD with 6mA DC leakage detection and therefore an external RCD is not usually required:

1. For cables without earthed metallic covering installed in walls or partitions at a depth of less than 50mm and also within walls and partitions with metal parts, and not protected by steel conduit or similar then RCD protection is required.
2. If the cable is clipped directly to the surface of a wall and does not pass through a wall or partition to the EV charger then a standard MCB may be installed into the Consumer unit, however RCD protection may be required for other reasons such as if it forms part of a TT system and the earth fault loop impedance values cannot be met. This will be in compliance with the current BS7671

Amendment 2 Wiring Regulations. To conform with BS 7671, on occasions a double pole MCB/RCD or other means of isolation may be required.

Important note: A DC Leakage fault in the vehicle may "blind" a type "AC" RCD and render it ineffective, never feed any EVSE From an upstream Type "AC" RCD.

Earthing requirements

The supplied EV charger features an on-board safety monitoring system to detect low or high voltage supplies and potential earth-neutral faults, this in accordance with regulation 722.411.4.1 (iv) of BS7671 2018. If such a condition is encountered the charge cycle is ended or prevented and the EV charger indicator flashes red and effectively becomes a double insulated (class II) device. The vehicle becomes isolated in accordance with Regulation 543.3.3.101(ii) from incoming supply and poses no risk to touch. This feature removes the requirement for an earth electrode where it may be ineffective or introduce further risk.

The EV charger may be connected directly to a TN-C-S (PME) earthing system without any special arrangements. It remains the responsibility of the installer to conduct a risk assessment of the immediate area to a range of 10 meters (equipotential zone) to ensure no other conductive metal fixings pose risks (mixture of TT/TN-S and TN-C-S), this is important where cable length may enable charging inside or outside of a building/ garage where the vehicle is within touch distance.

Where certain conditions dictate an earth electrode must be used it shall be independent from the distributors earth system with no direct interconnection (the incoming supply SWA protective earth should be isolated from the housing and/ or earth electrode). The electrical installer shall install a suitable electrode complete with termination housing and covers where appropriate, warning labels should be visible and close to the unconnected SWA protective earth, e.g. inside the charger.

The earth connection shall be made from the electrode to the charger via copper conductor earth wire of an appropriate CSA for the installation. The earth wire shall be installed in conduit where there is a risk of mechanical damage or UV exposure. Recommended Earth electrode impedance to be <100 ohms.

Isolation and switching for safety and maintenance

To ensure the EV charger can be "turned off" to enhance security and enable maintenance activities, a double pole isolator (or DP RCD or RCBO) suitably rated must be installed within the customer's property.

Installation requirements

The EV charger is suitable for installation inside and outside on a solid wall or structure.

The installer should consult with the building owner to establish their preferred installation location.

This should take into consideration the length of charging cable and risk of vehicle impact etc.

It is recommended the charger is installed at a height of 500mm-1500mm as per building regulations BS8300:2018.

If no suitable permanent structure is available, the EV charger can be mounted to a stand.

Ensure suitable fixings are used depending on the mounting surface. To avoid unnecessary dust inside the enclosure, it is recommended to use the included fixing hole template drill the surface, before fitting the enclosure.

Ensure installation wall has been checked for electric cabling or pipework with a suitable detector.

NOTE: if any groundworks are required e.g. cable trenching or earth electrode fitment, it is advisable to check if underground services could be present before commencement. Plans may be available at: www.linesearchbeforeudig.co.uk (free to domestic users).

The EV charger is suitable for bottom or rear cable entry, if using rear cable entry ensure the rubber grommet is used to maintain the IP rating.

When using Loop In / Loop Out installation method use one of the bottom cable entry points to link to the next charger.

Do not drill alternative cable entries into the charger housing, except marked cable entry location for bottom entry.

We recommend using Power & Data Combined cable on installs that require a CT clamp or Balancer to use the chargers dynamic load management capabilities.

All of the cables that are to be connected into the supply connector should have their insulation striped back 18-20mm. Connectors supplied are suitable for cables of 35mm².

Load balancing

If load balancing is required, a single CT clamps will be required for correct balancing on three phase power. We suggest the use of Sync Energy CT clamps, EVA120CT1 or EVA400CT1 depending on cable incoming size (Not supplied). These should be fitted around the incoming power to the main fuse and the correct max load (A) to be entered during setup and installation steps.

Load Balancing Multiple chargers

If load management for more than 1 charger is required please see EV Balancer at sync.energy for more details on how to dynamic load manage up to 16 chargers at once.

MID Meter For Billing Purposes Only

MID Meters are built into the charger as standard and report their usage on the charger screen, alternatively the MID meters have a screen which can be viewed internal of the product.

Final Electrical testing

To meet the BS7671:2018 (18th edition) requirements for testing of an electrical installation, the following tests and checks shall be performed by a competent electrical installer before during and after a Sync Energy charger is installed:

- A visual inspection of the installation including the existing electrical installation
- Verification of the characteristics of the electrical supply at the origin of the installation to confirm the supply is suitable for the additional load

- A test to confirm the continuity of the circuit protective conductors
 - A test to confirm the integrity of the circuit insulation resistance
 - A test to confirm the polarity of the installation is correct
 - Where applicable a test to confirm the earth electrode resistance is within acceptable tolerances
- (or)
- An earth loop impedance test
 - A test of the mechanical operation of residual current devices (RCD's)
 - A test to confirm the operation of residual current devices (RCD's) is within stipulated time scales (at the rated current and at five times the rated current operating current)
 - A test or calculated measurement of the prospective fault current
 - A verification of the functional operation of the EV charger
 - An electrical installation certificate must be completed

Ensure electrical testing is done before EV charger commissioning and network setup is performed.

For this testing, the Charger can be set to **"Installation Mode"** in the installation App.

Electrical Installation

- 1 Isolate the power



- 2 Remove the mounting bracket from the charger



- 3 Use the bracket as a template for

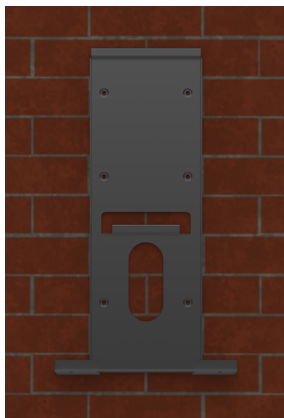

4

If rear cable entry, open the charger front and pre drill the entry port, if bottom entry skip this step

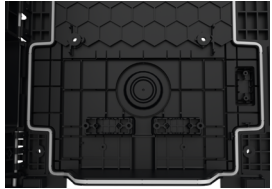
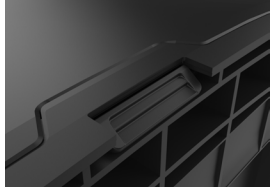

5

Fit the charger to the mounting plate ensuring to use the 2 bottom screws to secure the charger



6

If Bottom entry, open the front of the charger and drill to suit cable gland size, if rear entry skip this step



7

Ensure correct polarity when making incoming power connections



8

For dynamic load balancing, insert wires into the small connector

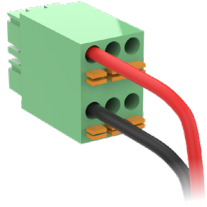

If using external 485 meter, then dip switch 3 needs to be changed to 'On'

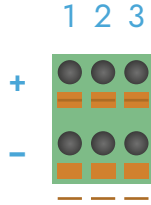

	1	2	3
+	485A		CT+
-	485B		CT-

9

Plug connector into PCB, ensure correct polarity

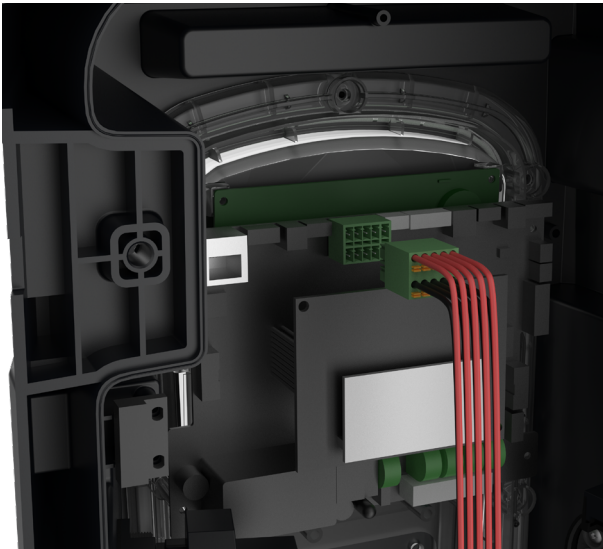

10

Once all connections are done and secure, close the charger cover and tighten fixing screws – ensure the MCB in the charger is turned on



11

Clip the Fascia plate onto the front of the charger, ensure the tabs clip into the body of the charger



12

Fit locking screws to secure the cover

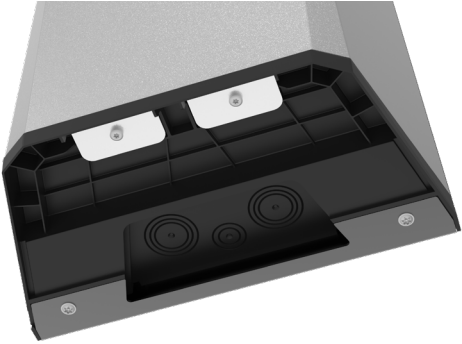

Commissioning Stage 1 of 2

INSTALLER APP – [Download the 'SyncEnergy' app by clicking this link](#)

Also available from the Installer Portal on the [sync.energy website](#), or using the QR code opposite.



Intuitive Interface: The revamped interface is designed with the installer in mind. Everything you need is available through a new side-menu

Effortless Setup: seamlessly configure your EV Chargers and balancer devices with just a few taps. Get up and running in no time

Account Management: Create and manage your account effortlessly. Keep a history of all your installed Chargers.

Upon Powering the charger, the status indicator light will show Yellow. This indicates that the charger is ready for network setup but is not yet connect to the internet. These steps are still required for 4G connected versions for setting of Dynamic Load Management.

For Wi-Fi connection, we recommend that the router is set to only 2.4GHz band to reduce the risk of possible conflicts. Once setup the router can be restored to both 2.4Ghz & 5Ghz bands.

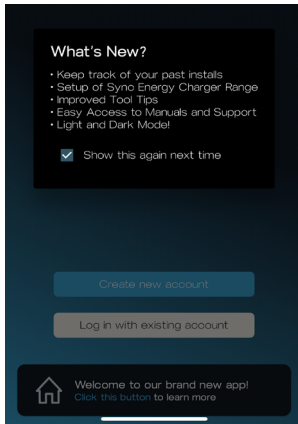

- 1 Open the SyncEnergy Installer App, If this is the first time you will be required to create an account. This will give you a history of the chargers installed and further help options.

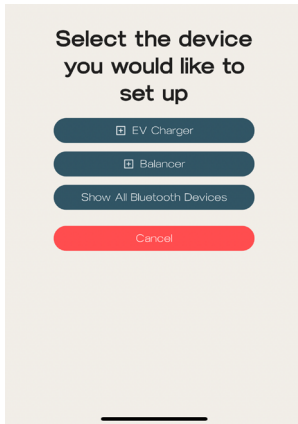

- 2 Ensure Bluetooth is activated on your device, and select set up new product. If the EV charger does not show up under EV Charger option, go back and select show all Bluetooth devices. If no Bluetooth devices are shown, please check Bluetooth is turned on and the permission was granted in the app.

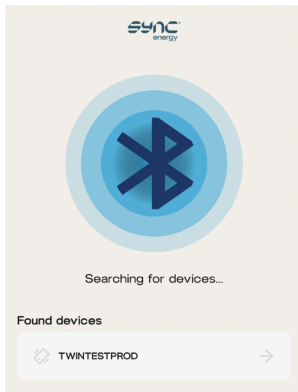

- 3 Select the correct EV Charger that matches the Charger ID code as shown on the charger identification label.

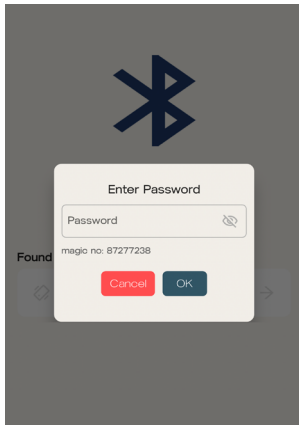

4

Then enter the password shown on the identification label.



5

A. Full EV Charger Setup allows full set up of Load balancing and other settings.

B. Network Set up allows quick Wi-Fi or Lan connection to be changed and set up.

Charger Management Software

Charger Server ⓘ

Monta

Charging Settings

Charger Mode ⓘ

APP

Max Charger Current ⓘ

32A

Indicator Brightness ⓘ

100 %

Local Charger Settings

Offline Charging ⓘ

Charger ID ⓘ

TWINTESTPROD

6

Charger Server: Select "Monta" – this is the included App. "Ev.Energy" and "SyncEV" are alternative options (additional costs may be incurred). "Manual" can be used for other alternative back offices. If unsure, Choose "monta".

7

Charger Mode: "APP" for smart charging via the consumer App (see next page); "Plug and Charge" if connection to the server cannot be established and immediate car charging is required.

8

Max Charger Current: Set to max current supported by installation if less than the default 32A.

- 9 **Indicator Brightness:** Adjust from 1 to 100% to change the brightness of the status indicator.

- 10 **Local Charger Settings:** Offline charging is enabled as default, for commercial paid charging we recommend this is disabled. This controls if the charger will allow a charge to start while not connected to the back office system.

- 11 Charger ID can be changed as required for other user Apps, We Recommend this is not changed unless critically required.

Press Save and Proceed to the save these settings.

Local load Management

Dynamic load Management

Secondary Device (Slave Unit)

Clamp Configuration

Home Max Current A

CT Clamp Ratio

Balancer Setting

Multi-charger Management

Phase Rotation

Balancer could be used to manage multiple chargers from a single measurement point.

Save and Proceed

12

Dynamic Load Management: If Dynamic Load management or Integrated SolarCharge is required, then toggle right.

If the charger is been used in the Master/ Slave load management configuration turn on Secondary Device to enable the charge point to be Slave unit, by default when turned off it will be Master unit.

Select CT configuration on the Master Unit.

Enter the properties fuse or maximum circuit rating. This will reduce the charge rate if the property is near the set limit.

13

Balancer: This should be enabled if using the Balancer Multi-Charger hub, and then the correct phase rotation enabled. Circuit limits are set on the balancer unit only. Press Save and Proceed to save these settings.

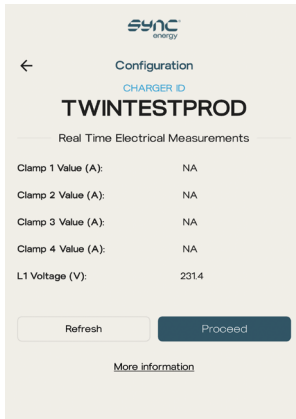

14

Check the shown electrical measurements match the measured readings. This will allow checking the load management CT is fitted in the correct orientation and location. A negative value indicates reverse direction of power due to, e.g Solar surplus, but could also indicate that the clamp has been installed in a reversed (incorrect) orientation or polarity wiring.

CHARGER ID

TWINTESTPROD

Double Connector Parameters

LCD Pin

Screensaver Time

 Sec

Date/Time

Time Zone

15

Screen Configurations can be managed here such as - Screen PIN set as a 4 digit number, Screen saver time (in seconds) determine the amount of stand by time before the screen returns to the default screen saver time, check the time and date matches before pressing save and proceed.

CHARGER ID

TWINTESTPROD

Please select the connection methods. You may select more than one.

Priority of connection is LAN > Wi-Fi > 4G (if the device supports it).

Wi-Fi LAN 4G

Wi-Fi Settings

16

For connecting to the network, ensure the required connection method is enabled. Choose between Wi-Fi, 4G (where supported) and LAN.

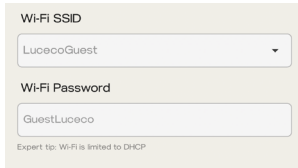

Wi-Fi SSID

LucecoGuest

Wi-Fi Password

GuestLuceco

Expert tip: Wi-Fi is limited to DHCP

For Wi-Fi, select the SSID network name and enter password.

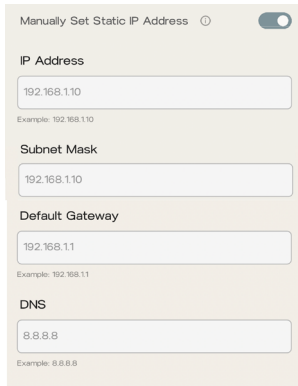

Manually Set Static IP Address

IP Address

192.168.1.10

Example: 192.168.1.10

Subnet Mask

192.168.1.10

Default Gateway

192.168.1.1

Example: 192.168.1.1

DNS

8.8.8.8

Example: 8.8.8.8

For LAN, ensure that "Manually Set Static IP Address" is disabled (unless advanced settings are required).

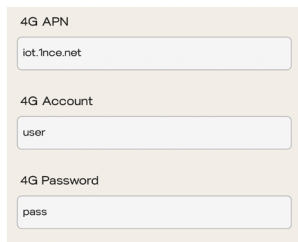

4G APN

iot.1nce.net

4G Account

user

4G Password

pass

For 4G, the settings will have been pre-configured where supported. Multiple options can be selected if required, this will allow a fall-back, e.g from Wi-Fi to 4G if fitted in case of network loss.

17

On LAN, the charger will default to DHCP. If static IP is required for the network connection, set the option "manually Set Static IP Address" to On and a manual IP address can be entered.

18

Press Save and Proceed to start network connection.

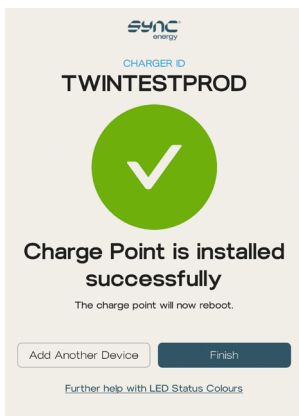

19

The Charger will attempt a network connection, if successful will then reboot to complete an RCD and safety function check.



In less than 2 minutes, the indicators should turn from Yellow to Blue to confirm network connection.

If the charger continues to show yellow, power cycle (switch off/on at fuse board) and reconnect via the app to check the settings are correct.

If still unable to connect to the network but need to use the charger then change the Charge Mode to '**Plug and Charge**' and press '**SET**' again to re-update settings.

If unable to establish network connection call **01952 983 940** or email: **support@sync.energy**

Note: The network connection from the device to the Internet is fully encrypted and secure. Additionally, no user data is stored on the charger.

Domestic Commissioning Stage 2 of 2

- 1 Download the Monta smart app:

[Apple app store
click here](#)



[Google play store
click here](#)



or search for '**Monta EV charging**' on
Apple app store or Google Play

- 2 Using your smart-phone scan the unique
Monta QR Code on the '**Quick Start Guide**'
sheet supplied with the EV Charger.
If you're unable to use the QR, open a web
browser on your smart-phone and manually
type the URL on the sticker

- 3 Open the Monta app

iOS

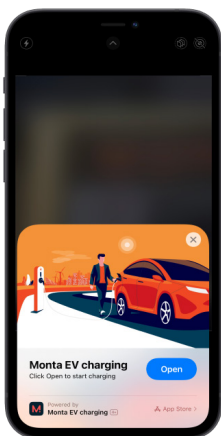

Android

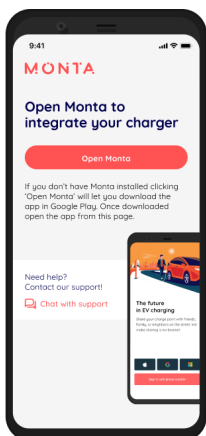

4

Create an account using your customers phone number or social logins (Apple/Google/Microsoft)

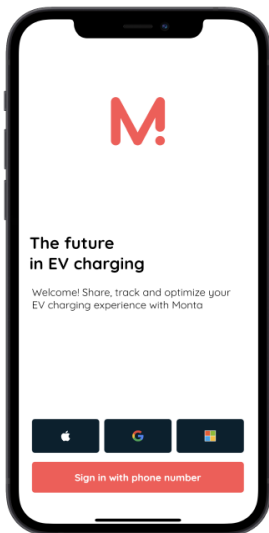

5

Connect the EV charger to Monta – select the socket outlet, name the charge-point and set the location

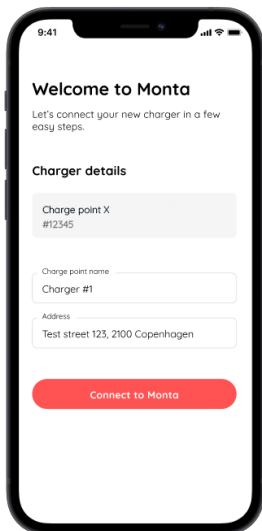

6

Successful connection – When you reach this step, repeat for the second socket outlet

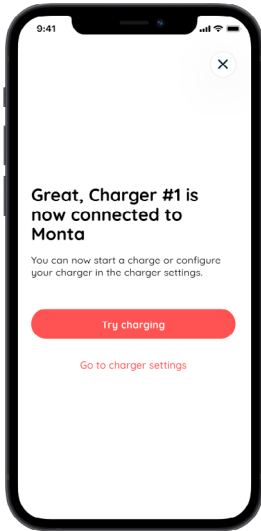

7

Once both sockets are connected your charge-point is fully integrated and you can use Monta to start charging

Need help with the app?

Contact Monta customer support through the app or via the website [Monta.com](https://www.monta.com)

Need help with the charge-point?

Contact Sync Energy technical support at: support@sync.energy or via the website at www.sync.energy

Commercial usage with Billing installation & commissioning

Sync Energy can handle all management and set up for customers including setting up single or multi pricing / time of day usage tariffs and Payment Terminal set ups.

4 simple steps:

1 CONTACT

Email commercial@sync.energy with the charge-point owner contact details

2 CONNECT

Install the charge-points

3 CONFIGURE

Set the configurations in the Sync Energy installer app and connect all chargers to the internet

4 COMPLETE

Pass the charger details to the charge-point owner

How it works:

To streamline the process, email us [before the first day of installation](#) with the following information:

- **Model and charger ID**
(for every charger in the installation)
- **Payment Terminal SN/s**
(Where Applicable)
- **Contact details for the charge-point owner:**
 - Company name
 - Name of charge-point manager
 - Site address
 - Telephone number for charge-point manager
 - Email address for charge-point manager

Our Commercial Team will contact the charge-point owner to carry out the quick and simply Monta setup process.

By using this process we will have the back-office set up for installation day, ensuring all chargers are immediately ready for customer use once configured.

Technical information

Environmental Protection



This symbol is known as the "Crossed-out Wheellie Bin Symbol". When this symbol is marked on a product or battery, it means that it should not be disposed of with your general household waste. Some chemicals contained within electrical/electronic products or batteries can be harmful to health and the environment. Only dispose of electrical/electronic/battery items in separate collection schemes, which cater for the recovery and recycling of materials contained within. Your co-operation is vital to ensure the success of these schemes and for the protection of the environment.

Guarantee

Sync Energy products are guaranteed against faulty materials and workmanship for a period of 5 years from date of delivery: products will be repaired or (at Sync Energy's discretion) replacements will be supplied or (at Sync Energy's discretion) a credit note will be issued.

This guarantee is subject to Sync Energy's conditions of sale and in particular to the following conditions being met:

1. Notification of any defect is given to Sync Energy as soon as reasonably practicable after becoming apparent, and the products then returned to Sync Energy.
2. The products have only been operated under normal operating conditions and have only been subject to normal use.
3. No work (other than normal and proper maintenance) has been carried out to the products without Sync Energy's prior written consent.
4. The products have been assembled, or incorporated into other goods, by a qualified and recognised electrician and only in accordance with any instructions issued by Sync Energy.
5. The defect has not arisen from an item manufactured or supplied by a person other than Sync Energy.
6. 5 year warranty as standard, optional product registration can be completed on the Sync Energy website.

[Follow this link to visit our Warranty web-page](#)



Technical data

PART NO:	EVPCWSM27BGR Wall Mounted with 4G, MID Meter - Single Phase
	EVPCWSM27BGRP Wall Mounted with 4G, MID Meter & Payment Terminal - Single Phase
SOCKET TYPE:	Type 2 with Autolock
MAX OUTPUT:	2 x 7.4kW or 1 x 7.4kW / 2 x 3.6kW, 32A
MAX INPUT:	100A, 230-240V
TO SPECIFY:	Wall Mounted, Twin Type 2 Socket, EV Charger with Touchscreen, 4G connectivity, RFID, and Contactless card payment options. Compliant with PAS 1899:2022 accessibility standards, equipped with MID meters, RCD Built in protection, MCB over current protection, PEN fault protection and Loop in Loop out input terminations up to 35mm ² cable, with IP65 and IK10 rating. Made of Stainless Steel and Polycarbonate
ACCESSIBILITY:	PAS 1899:2022 Compliant when installed as per guidance



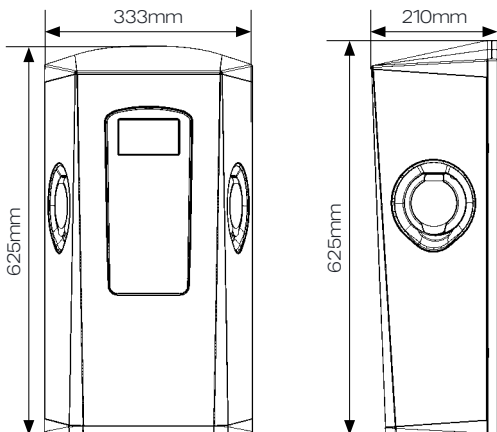

Electrical Specifications

SUPPORTS DAISY CHAIN INSTALL:	Yes, up to 35mm ² cable
INPUT CABLE MAX SIZE:	35mm ²
MAX INPUT (A):	100A
INTERNAL OVERCURRENT RATING (A):	80A - Single Phase, 2x40A - Single Phase
INPUT VOLTAGE:	220-240V (Single Phase)
INPUT FREQUENCY:	50-60hz
PEN FAULT:	Built in
RCD PROTECTION:	Built in 30mA AC Type A & 6mA DC Protection
ELECTRICAL CLASS:	Class 1 with Class 2(II) insulated Housing
ENERGY METER:	Integrated Class B MODBUS MID Meter
TEMPERATURE MONITORING:	Yes
WELD DETECTION:	Built In

ANTI TAMPER DETECTION:	2 Layer Protection built in
OVER VOLTAGE:	Built In

Operating Conditions & Construction

STORAGE:	-30 to 55°C
OPERATING:	-25 to 40°C
RELATIVE HUMIDITY:	5-95%
IP RATING:	IP65
IK RATING:	IK10 Body, IK08 Screen
POWER DISSIPATION:	8W Standby
MOUNTING:	Wall Mounted, Multiple wall fixing locations, up to 375mm x 150mm fixing centres
MATERIAL:	Stainless steel and Polycarbonate
COLOUR:	Black RAL 9005, Grey RAL 9006
DIMENSIONS:	625 (H) x 333 (W) x 210 (D)

Screen layout

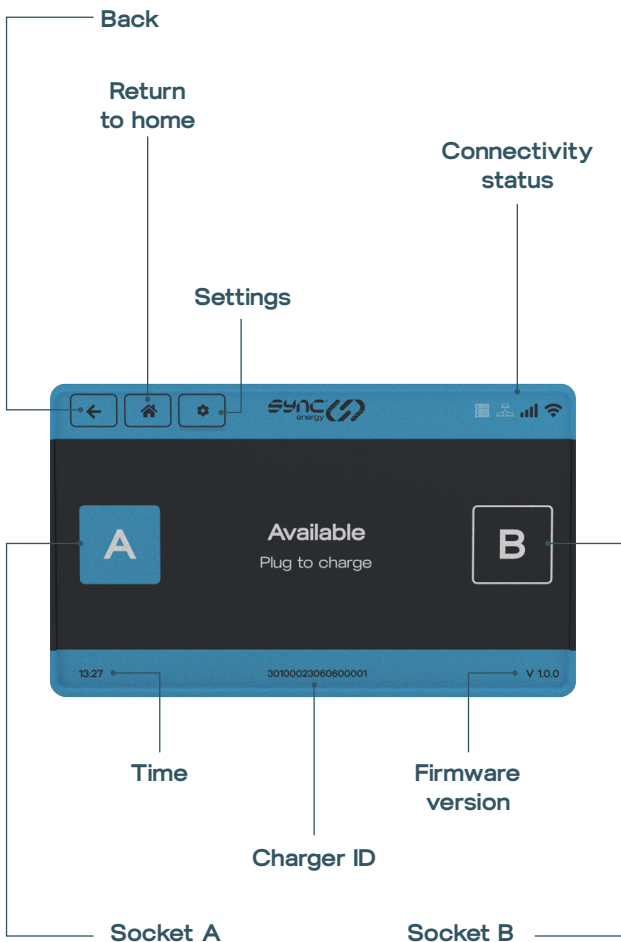

Troubleshooting

For further information, or to refer to our FAQs, please visit our website: www.sync.energy

The status of the EV charger can be identified by referencing the colour shown on the LED indicator:

- **Solid Blue – Standby** – Charger has power and is connected to the network. Or, if in 'plug and charge' mode is not connected to the network, is ready to charge.
- **Flashing BLUE** – Charger is connected but not charging, awaiting confirmation of charge in APP or scheduled start time
- **Solid Dark Green** – Charger is active and Charging
- **Solid Yellow** – Charger is offline from network, check local network is active and Wi-Fi is working on the 2.4Ghz band
- **Flashing Red** – Indicates the charger is in fault mode and has stopped charging for users safety
- **Flashing Purple** – Indicates the charger has stopped communicating with the Dynamic Load Balancer

Potential causes:

- Internal RCD has tripped
- Vehicle fault
- Under or over suitable charging voltage

Remove connection to the vehicle and reset power to the EV charger.

Technical support

Need help with the app?

Contact Monta customer support through the app or via the website [Monta.com](https://www.Monta.com)

Need help with the charge-point?

Contact Sync Energy technical support at:

support@sync.energy

or via the website at www.sync.energy

**Sync Energy is a trading name of
Luceco PLC**

Luceco PLC

Stafford Park 1, Telford, TF3 3BD, England

(EU) Luceco SE

C/ Bobinadora 1-5, 08302 Mataro, Spain